

2012 - 2016 Buick LaCrosse eAssist

2012 - 2016 Buick Regal eAssist

Emergency Response Guide



GM Service Technical College provides First Responder Guides (FRG) and Quick Reference (QR) Sheets *free of charge* to First Responders. FRGs and QRs can be displayed in a classroom as long as they are represented as GM information and are not modified in any way.

GM's First Responder Guides are available at www.gmstc.com

The intent of this guide is to provide information to help you respond to emergency situations involving the Buick LaCrosse and Regal eAssist vehicles in the safest manner possible. This guide contains a general description of how the Buick LaCrosse and Regal eAssist vehicle systems operate and includes illustrations of the unique components. The guide also describes methods of disabling the high voltage system and identifies cut zone information.



Vehicle Specifications

The Buick LaCrosse and Regal eAssist vehicles are front-wheel drive, five passenger hybrid electric vehicles. The eAssist system utilizes a high voltage battery, located in the trunk, as a supplemental power source. The system assists the engine utilizing a high torque belt driven starter / generator.

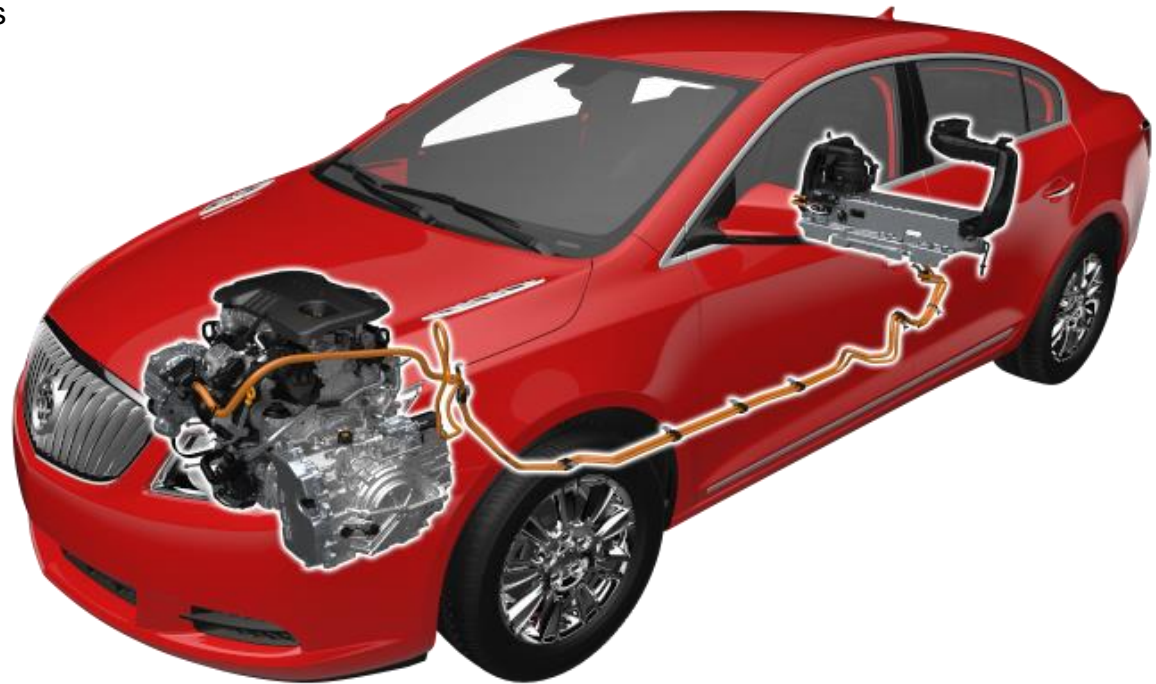

Vehicle Identification

The Buick LaCrosse and Regal eAssist do **NOT** use exterior badging to identify them as eAssist vehicles.

To differentiate between standard and eAssist Buick LaCrosse and Regal vehicles, look in the following places to determine if high voltage exists:

Under the hood features:

- Large orange cable connected to generator
- Yellow First Responder Cut Tape Label

Instrument panel cluster features:

- Economy gauge
- Auto stop position on tachometer

Trunk features:

- Battery label



Low Voltage System

There are two separate electrical systems within the eAssist vehicles: low voltage (12V) and high voltage (130V). The low voltage system is similar to a conventional vehicle.

The low voltage system provides the energy needed to enable the high voltage system, therefore, when approaching an emergency situation, the low voltage system must be disabled.

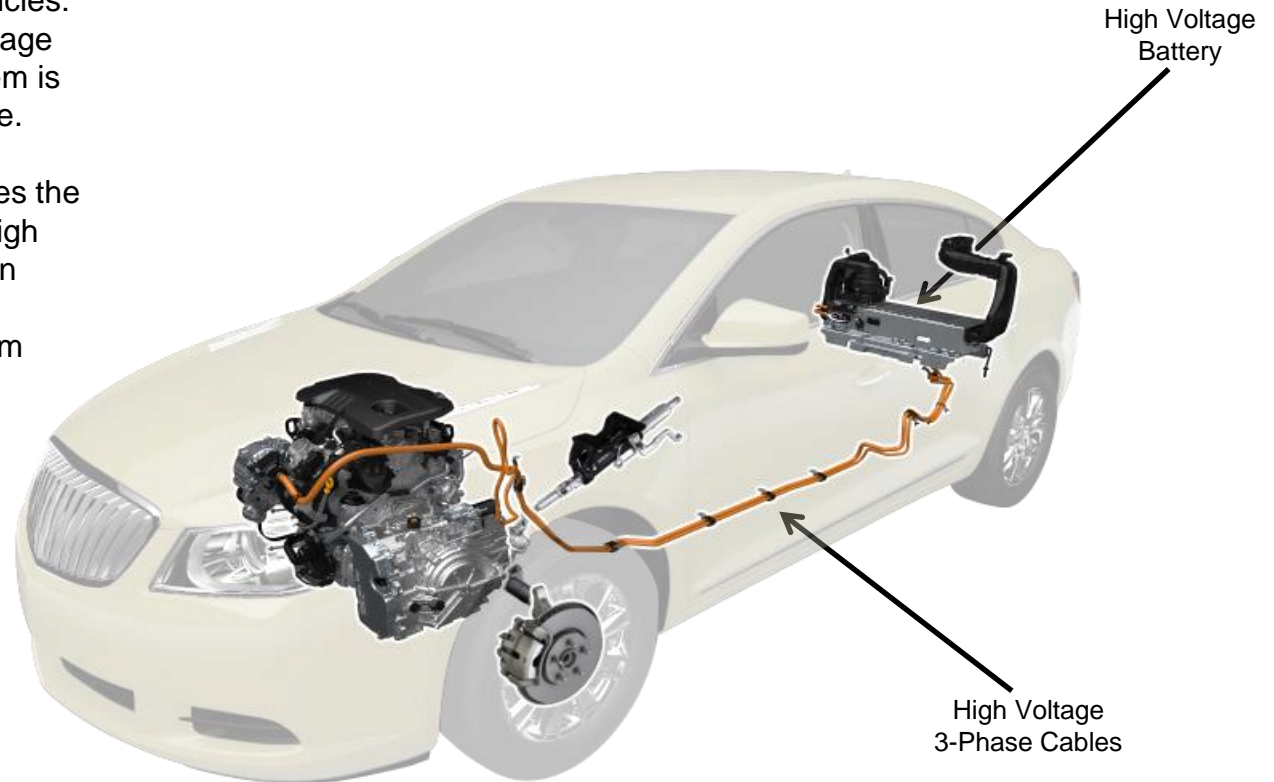

System Components

The Buick LaCrosse and Regal eAssist system is composed of the following components:

- High voltage starter / generator
- 3-phase electric power cables
- High voltage lithium-ion battery

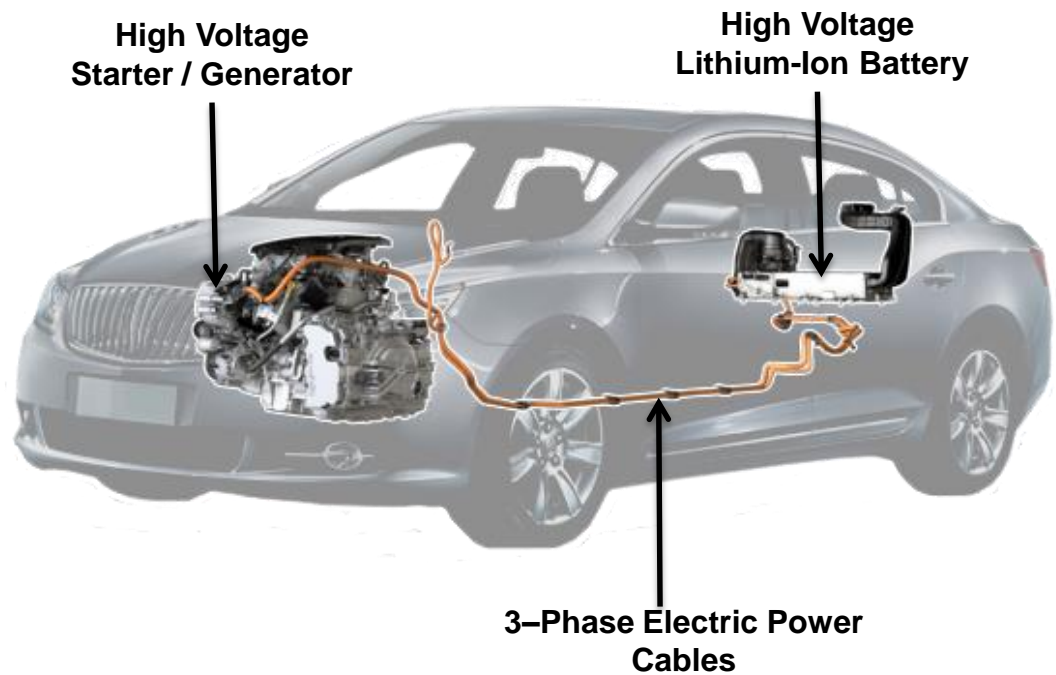

High Voltage Lithium-Ion Battery

The Buick LaCrosse and Regal eAssist system features a 130 volt lithium-ion battery, which provides electrical energy to the starter / generator. The high voltage battery assembly is located in the trunk behind the rear passenger seats. The assembly includes several internal components that operate together to provide and control the high voltage for the eAssist system.



3-Phase Electric Power Cables

The 3-phase electric power cables connect the high voltage battery assembly to the starter / generator. These cables are housed in a labeled protective metal tubing under the vehicle.

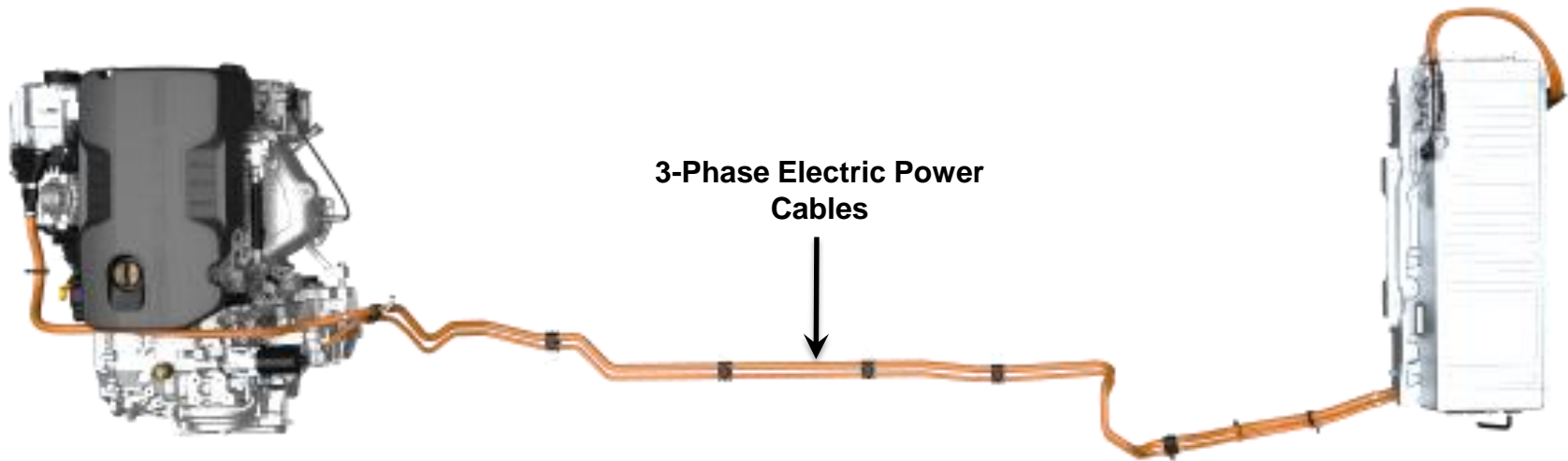

High Voltage Starter Generator

The eAssist system is designed to restart the engine after an auto stop and supplement engine torque on various powertrain configurations which improves fuel economy.

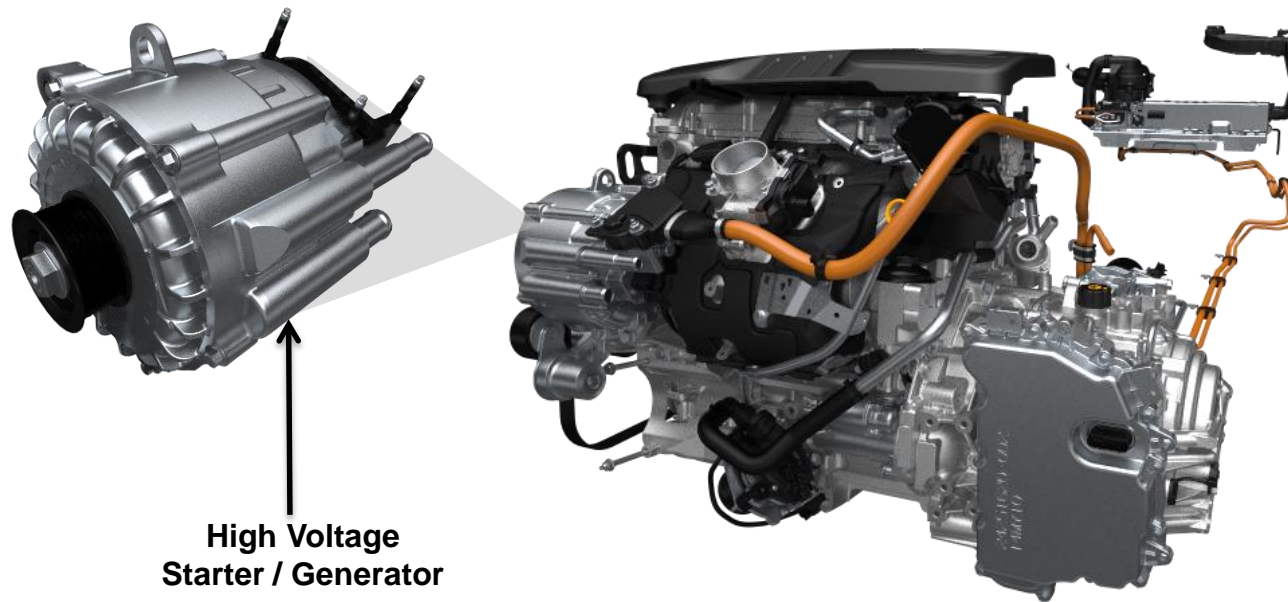

System Operation

The eAssist system is designed to shut the engine off or auto stop when the vehicle is NOT in motion, restart the engine after an auto stop, and supplement engine torque.

The eAssist system provides an electric boost to the powertrain system during heavy acceleration and grade driving. This boost enables the transmission to operate more efficiently. The added functionality of the electric boost, engine auto stop, and early deceleration fuel shut-off results in fuel savings.

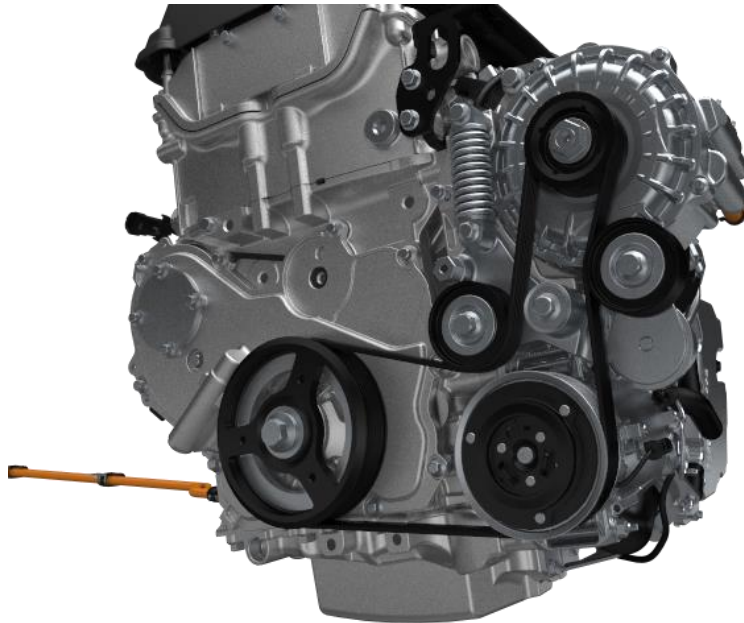

High Voltage Labels

The Buick LaCrosse and Regal eAssist system features a series of labels that enable quick identification of potential electrical hazards.

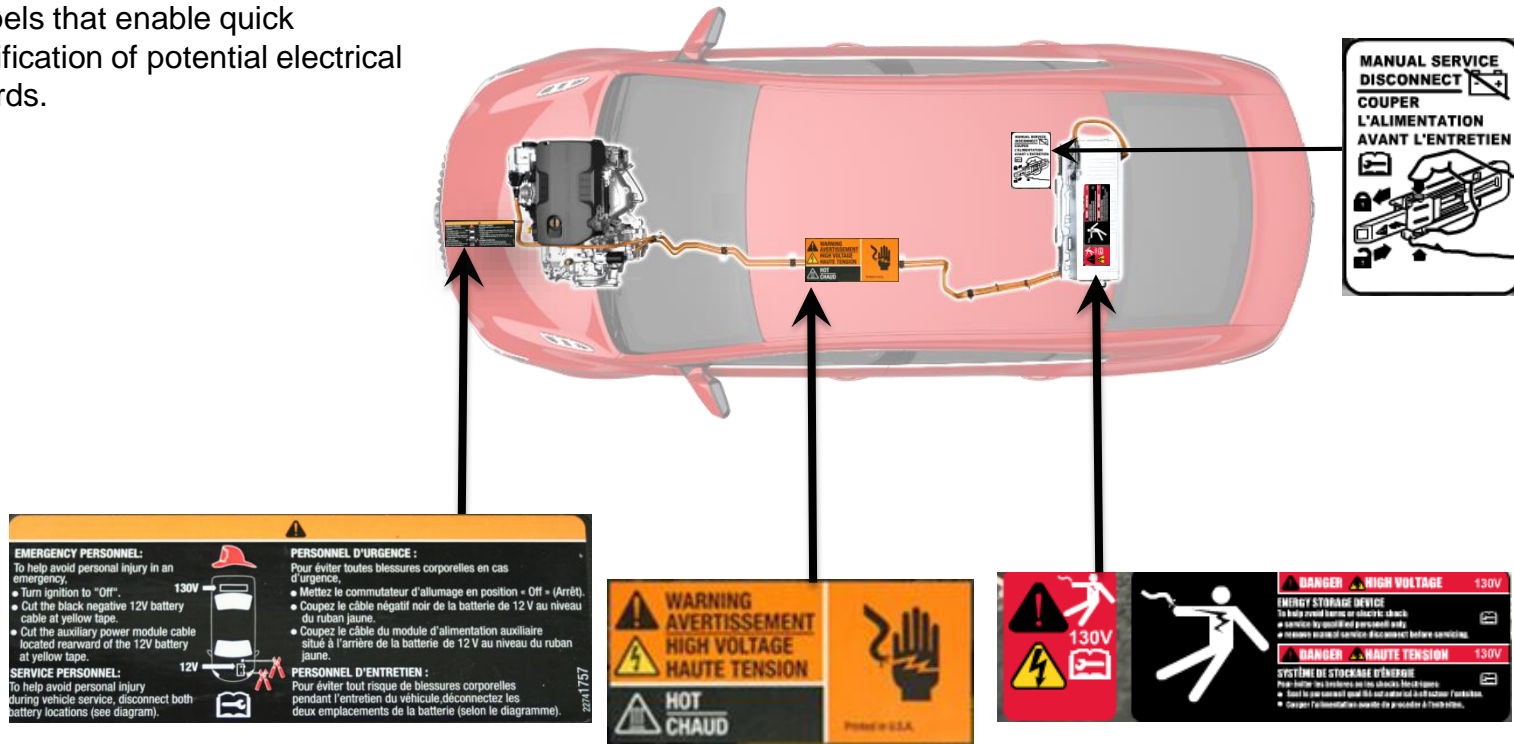

High Voltage Labels (Continued)

The first responder label located under the hood indicates the locations of the high voltage and low voltage batteries, as well as steps a first responder should take to disable the high voltage system.

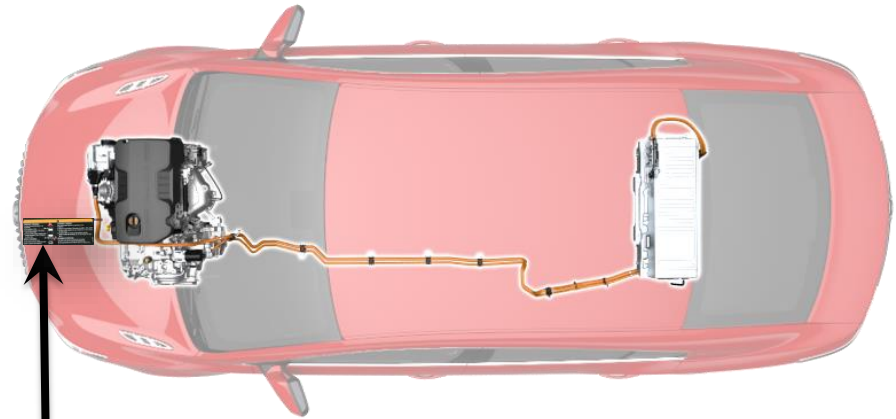

<p>EMERGENCY PERSONNEL: To help avoid personal injury in an emergency,</p> <ul style="list-style-type: none"> ● Turn ignition to "Off". ● Cut the black negative 12V battery cable at yellow tape. ● Cut the auxiliary power module cable located rearward of the 12V battery at yellow tape. 	<p>PERSONNEL D'URGENCE : Pour éviter toutes blessures corporelles en cas d'urgence,</p> <ul style="list-style-type: none"> ● Mettez le commutateur d'allumage en position « Off » (Arrêt). ● Coupez le câble négatif noir de la batterie de 12 V au niveau du ruban jaune. ● Coupez le câble du module d'alimentation auxiliaire situé à l'arrière de la batterie de 12 V au niveau du ruban jaune.
<p>SERVICE PERSONNEL: To help avoid personal injury during vehicle service, disconnect both battery locations (see diagram).</p>	<p>PERSONNEL D'ENTRETIEN : Pour éviter tout risque de blessures corporelles pendant l'entretien du véhicule, déconnectez les deux emplacements de la batterie (selon le diagramme).</p>

High Voltage Labels (Continued)

The high voltage warning labels are orange and indicate a potential shock hazard if high voltage is not properly disabled. The labels are located underneath the vehicle on all high voltage components with the exception of the high voltage battery which utilizes red danger labels. This tag will be visible if approaching a roll over incident.

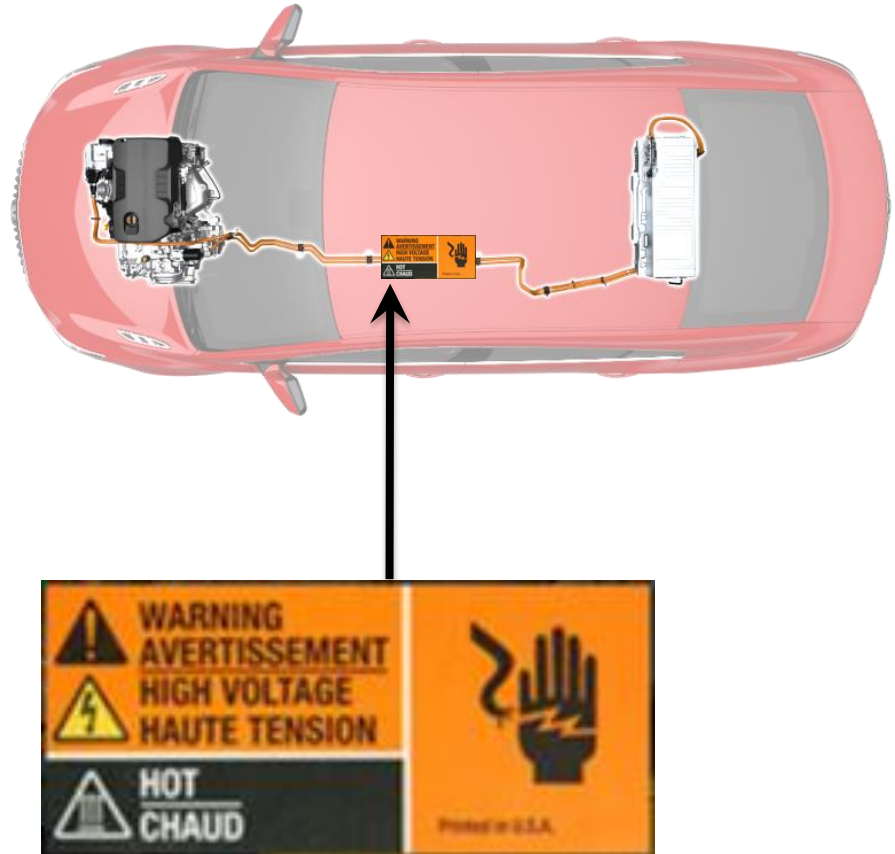

High Voltage Labels (Continued)

The manual service disconnect label located on the cover of the high voltage battery illustrates how to operate the manual service disconnect switch.

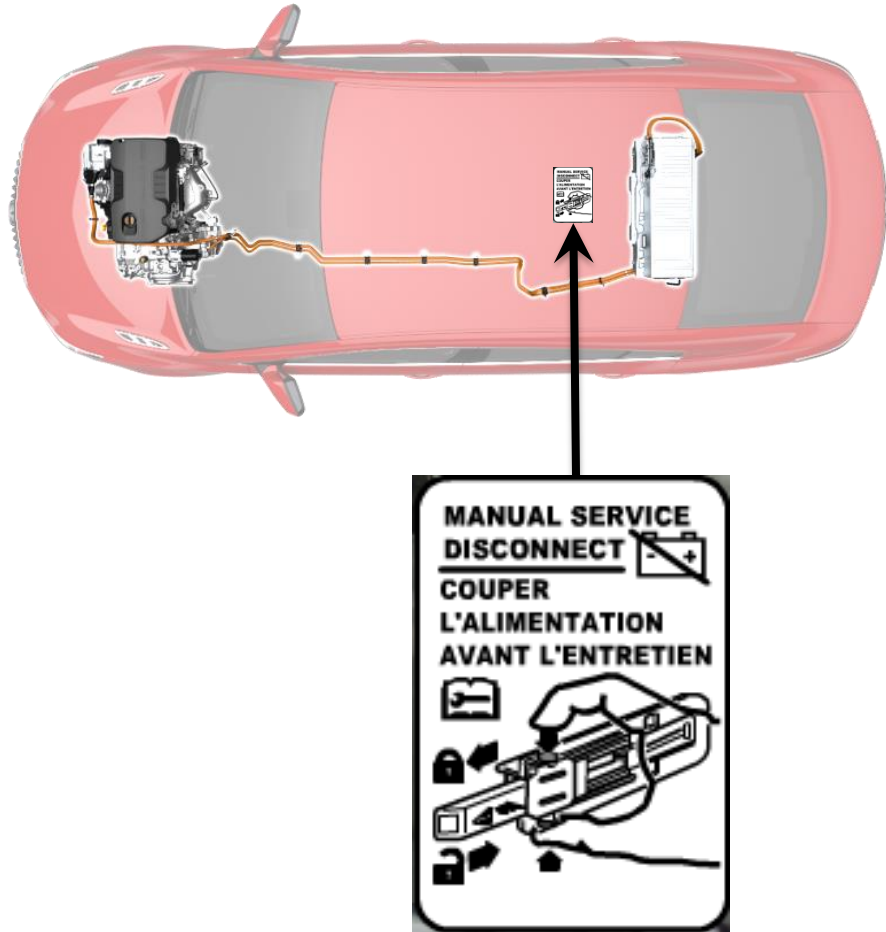

High Voltage Labels (Continued)

The high voltage danger labels are red and indicate that high voltage is present at all times. These labels are located on the high voltage battery in the trunk.

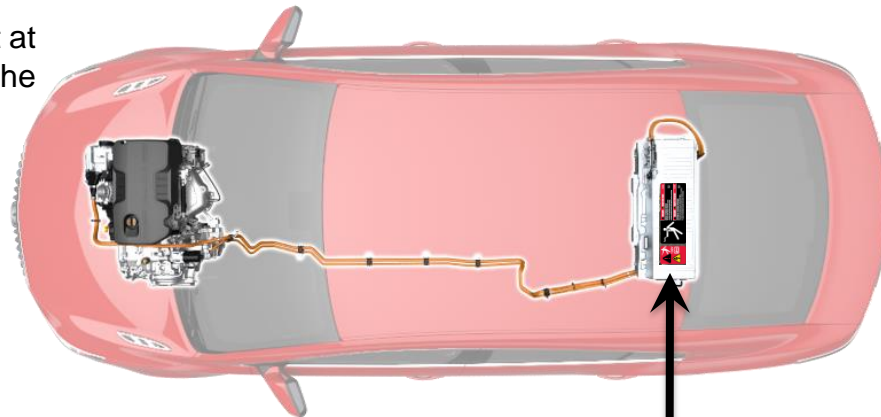

Cable Cut Labels

GM has implemented the labels shown here to help First Responders safely disable the air bags and high voltage system in an emergency situation. The yellow first responder cut tape labels are wrapped around the low voltage (12V) cables to indicate where emergency responders are to cut to disable air bags and the high voltage system.



Important:

Cut through the low voltage cables on each side of the yellow labels to remove a section of the cable to ensure the cables cannot inadvertently reconnect.

To Disable the eAssist System

To avoid personal injury in an emergency situation the eAssist system must be disabled.

To disable high voltage:

1. Turn ignition to "OFF" position
2. Cut the black 12 volt battery cable at yellow tape
3. Cut the auxiliary power module cable located rearward of the 12 volt battery at yellow tape

Note: After disabling 12 volt power, wait 1 minute to allow any un-deployed airbag reserve energy to dissipate.

Important:

To avoid accidental reconnection of the cut cable, remove a section of each cable to ensure they cannot inadvertently reconnect.



Use key or push button to turn off ignition



Auxiliary Power Module Cable

12 volt battery cable

High Voltage Cables - DO NOT CUT ZONES

The high voltage cables in the Buick LaCrosse and Regal eAssist vehicles are routed to minimize interaction with any extraction procedures. However, performing the high voltage disabling procedure prior to extrication work eliminates electrical current flow through the 12 volt system and disables the high voltage electrical system. No further action is required.

DANGER: Do NOT cut the orange high voltage cables. Cutting these cables can result in serious injury or death. No matter what disable method you have performed, always assume the high voltage cables and components contain high voltage.



Buick LaCrosse and Regal eAssist Airbags

The LaCrosse and Regal are equipped with six standard airbags to protect the occupant in front, side and rollover crashes. There are two optional thorax airbags located within the rear seat back of the LaCrosse.

There are also dual pretensioner seatbelts that work together with the airbag system to protect the occupant in the event of a crash.



Airbag Deployment

The contactor within the high voltage battery is commanded open whenever one or more airbags deploy. This interrupts the 130 volt electrical system and discontinues current flow through the high voltage cables.

This vehicle is equipped with dual-stage airbags and the appearance of deployed airbags does NOT ensure all stages of the airbags have deployed.



High Strength Steel

The LaCrosse and Regal are designed to protect the occupant(s) during a collision. The body structure contains high strength steel; this is highlighted in blue. The occupants are protected from front, rear and side impacts by a structural cage created by the underlying vehicle structural design.

Additional crumple zones protect the occupant with front, side and rear rails that are designed to crush in a crash.

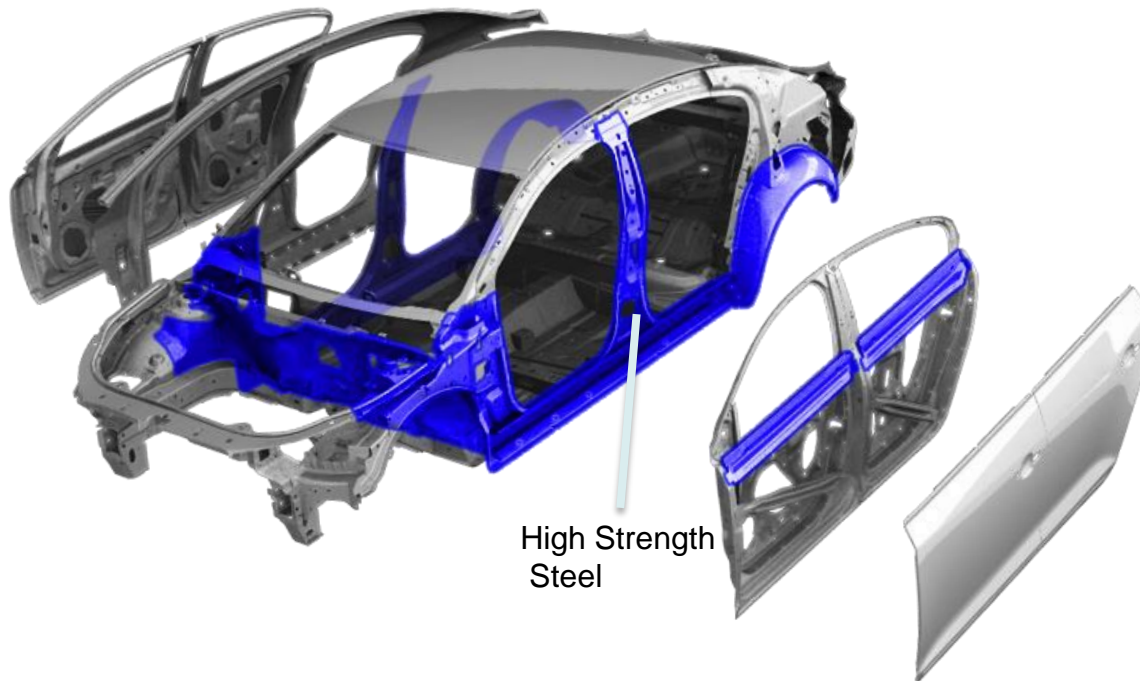

Vehicle DO NOT CUT ZONES

Do NOT cut the:

- Roof rails near the center pillar, contains side curtain airbag inflators.
- Front seat back on the outboard edge, contains side airbags.
- Center pillar near the rocker, contains the seat belt retractor pretensioner and side impact sensor.

WARNING: Do NOT cut into the vehicle until the 12V electrical system has been disabled. Cutting into the vehicle prior to disconnecting and isolating the 12V electrical energy sources may cause airbag deployment resulting in serious injury.

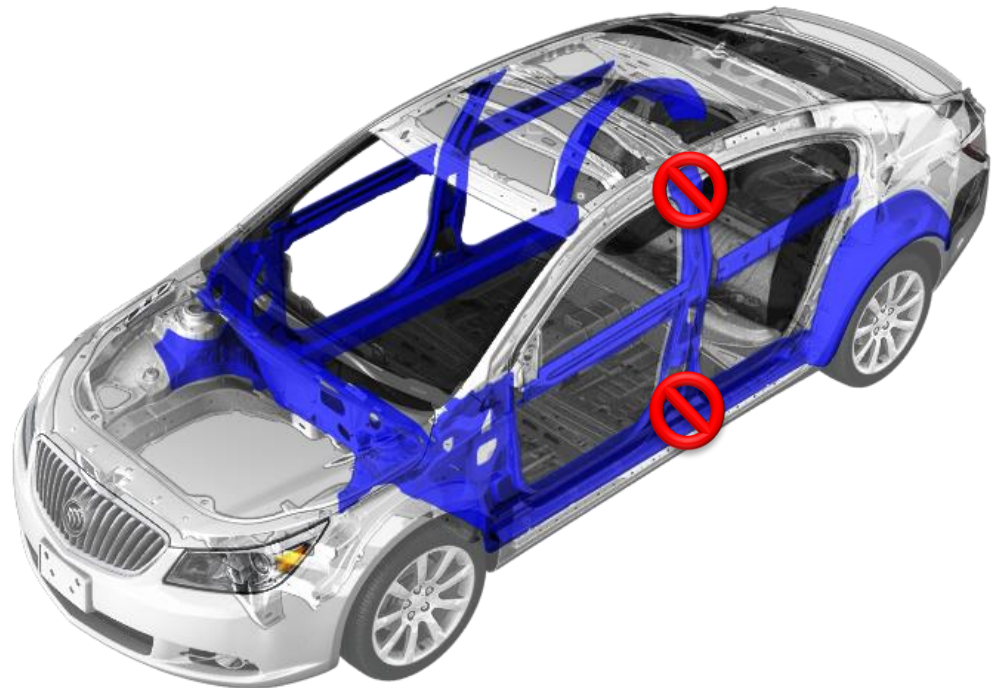

First Responder Considerations

Fire

The battery on fire will not explode. If battery cells reach high enough temperature, they vent and release electrolyte. Battery electrolyte is flammable. Use copious amounts of water to cool the battery and extinguish the fire. ABC dry chemical extinguisher will not extinguish a battery fire.

Water

The high voltage battery is isolated from the vehicle chassis. If the vehicle is immersed in water, you will not be electrocuted by touching the vehicle.

Locate and review the Lithium-Ion Battery Chemistry Material Safety Data Sheet for more information.



Conclusion

General Motors is committed to making your job as safe as possible.

We are confident the information contained in this guide will prove useful as you prepare to assist those involved in an emergency event.



For information regarding modification of GM's First Responder Information for other uses, contact GM's Licensing Manager at: GM Licensing Program Hdqtrs, 5775 Enterprise Ct. Warren, MI 48092, Attn: Licensing Coordinator