

2011 - 2015 Chevrolet Volt

Emergency Response Guide



GM Service Technical College provides First Responder Guides (FRG) and Quick Reference (QR) Sheets *free of charge* to First Responders. FRGs and QRs can be displayed in a classroom as long as they are represented as GM information and are not modified in any way.

GM's First Responder Guides are available at www.gmstc.com

The intent of this guide is to provide information to help you respond to emergency situations involving Chevrolet Volt vehicles in the safest manner possible. This guide contains a general description of how the Chevrolet Volt vehicle systems operate, identifies the location of the unique badging, and includes illustrations of the unique components. The guide also describes methods of disabling the high voltage system and identifies cut zone information.



The Chevrolet Volt is a front-wheel drive, four-passenger electric vehicle with extended-range capability. The vehicle is propelled exclusively by electric motors. The Volt uses high voltage energy that is stored in the high voltage battery as its primary power source. However, once the battery capacity is reduced, the gasoline engine drives a generator which produces electricity to power the vehicle.

Vehicle Identification

The Chevrolet Volt badging is one method of identifying the vehicle. The vehicle's logo is located on the right-front and left-front fenders as well as the deck lid.

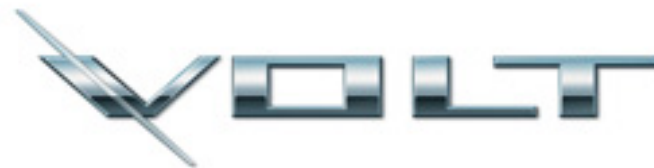

Vehicle Identification (continued)

A unique Liquid Crystal Display (LCD) instrument panel cluster assists in identifying the Chevrolet Volt.



System Components

The Chevrolet Volt propulsion system is composed of the following components and systems:

- High voltage battery
- Absorbent Glass Mat (AGM) low voltage battery (12V)
- Power inverter module
- Accessory power module
- High voltage battery charger
- 1.4 Liter Engine
- 4ET50 transmission

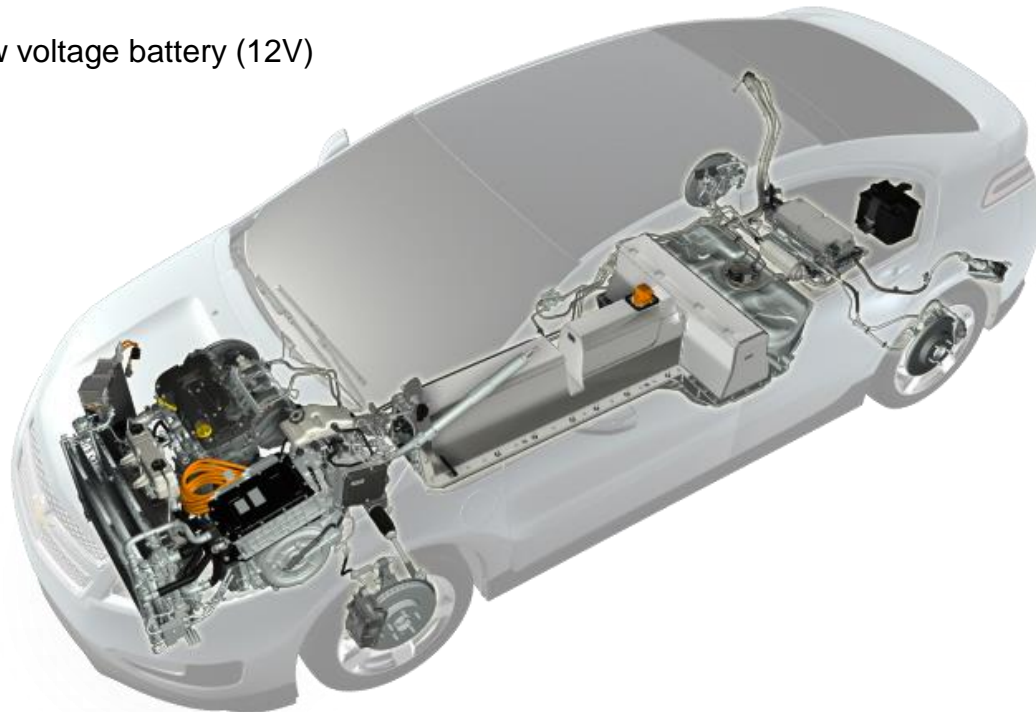

High and Low Voltage Batteries

The high voltage battery, also known as the drive motor battery, is a system of many components that operate together to provide the energy required for vehicle propulsion. High voltage contactors, internal to the battery pack, turn on and off to control the output of the high voltage battery.



High Voltage Battery

The Chevrolet Volt's low voltage system (12V) utilizes an AGM lead acid battery. The battery is located in the rear compartment underneath the load floor. The low voltage energy is utilized by vehicle modules to control the high voltage battery contactors. Severing the low voltage cables should cause the system to open the contactors. The low voltage (12V) cable cut location is found behind the left rear closeout panel in the rear compartment of the vehicle.



Low Voltage AGM Battery

Power Electronics

The power inverter module is located on the drivers side of the engine compartment and is mounted on top of the transmission. The module changes the high voltage direct current into 3 phase alternating current. This 3-phase electrical energy is provided to the motors within the transmission for vehicle propulsion.

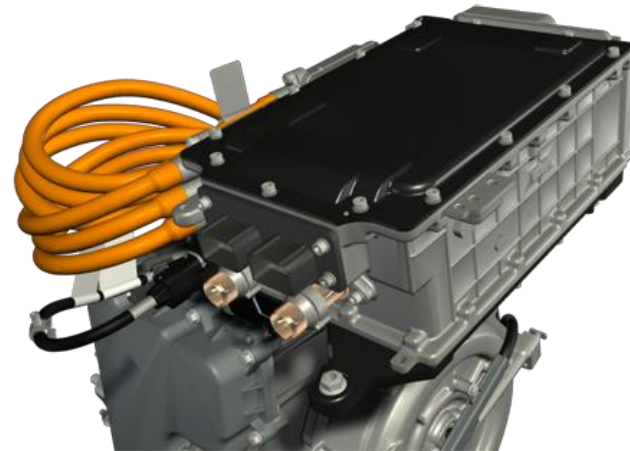

Power Inverter Module



Accessory Power Module

The accessory power module is located in the rear compartment beneath the load floor. The module replaces the belt-driven generator common to conventional vehicles. The module converts high voltage DC electrical energy into low voltage DC electrical energy to provide the energy needed for the vehicle systems.

Charging System

The Chevrolet Volt features an onboard high voltage charging system that recharges the high voltage battery. The system utilizes a unique cord to connect the vehicle to an electrical receptacle. The charger is located behind the passenger headlamp assembly and bumper fascia. The charger converts household AC into DC voltage to charge the onboard battery.

The vehicle charge port provides the interface between the cords, plug, and the charger.

In the event a Volt is involved in an incident while the battery charger is plugged in for charging the battery, remove the charge cord from the car using the charger cord handle at the charge port in the left front fender. If that cannot be accomplished, the electrical power to the charge cord should be terminated at the source.



Vehicle Charge Port

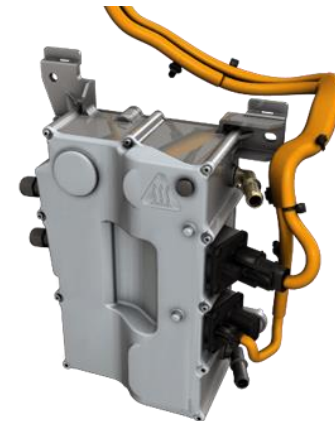

High Voltage Charger

Powertrain



The 4ET50 transmission is a fully automatic, front-wheel drive transaxle, variable-speed, electronic controlled transmission. The transmission contains two electric motor / generators that are utilized to:

- Propel the vehicle
- Generate / recapture energy
- Start the internal combustion engine

The Chevrolet Volt uses an internal combustion 1.4L engine. The engine does not directly propel the vehicle, but operates only to spin the drive motor / generator.

System Operation

The Chevrolet Volt is an Extended Range Electric Vehicle (EREV) that uses an electric propulsion system to drive the vehicle. Stored electrical energy is used in electric mode to propel the vehicle. The vehicle operates up to 64 kilometers (km) or 40 miles (mi) until the battery has reached a low state of charge. Once the stored electrical energy is reduced, the vehicle automatically enters extended-range mode. The gasoline engine drives the generator which produces electricity for vehicle propulsion.



System Operation (continued)

There are two separate electrical systems, low voltage and high voltage. The low voltage system is similar to a conventional vehicle. The high voltage electrical system distributes 360 volts Direct Current (DC) between the high voltage components and 3-phase Alternating Current (AC) to the transmission.

The high voltage cables are orange in color to easily identify the potential existence of high voltage. High voltage cables that are routed through non-orange conduit are identified with high voltage warning labels.

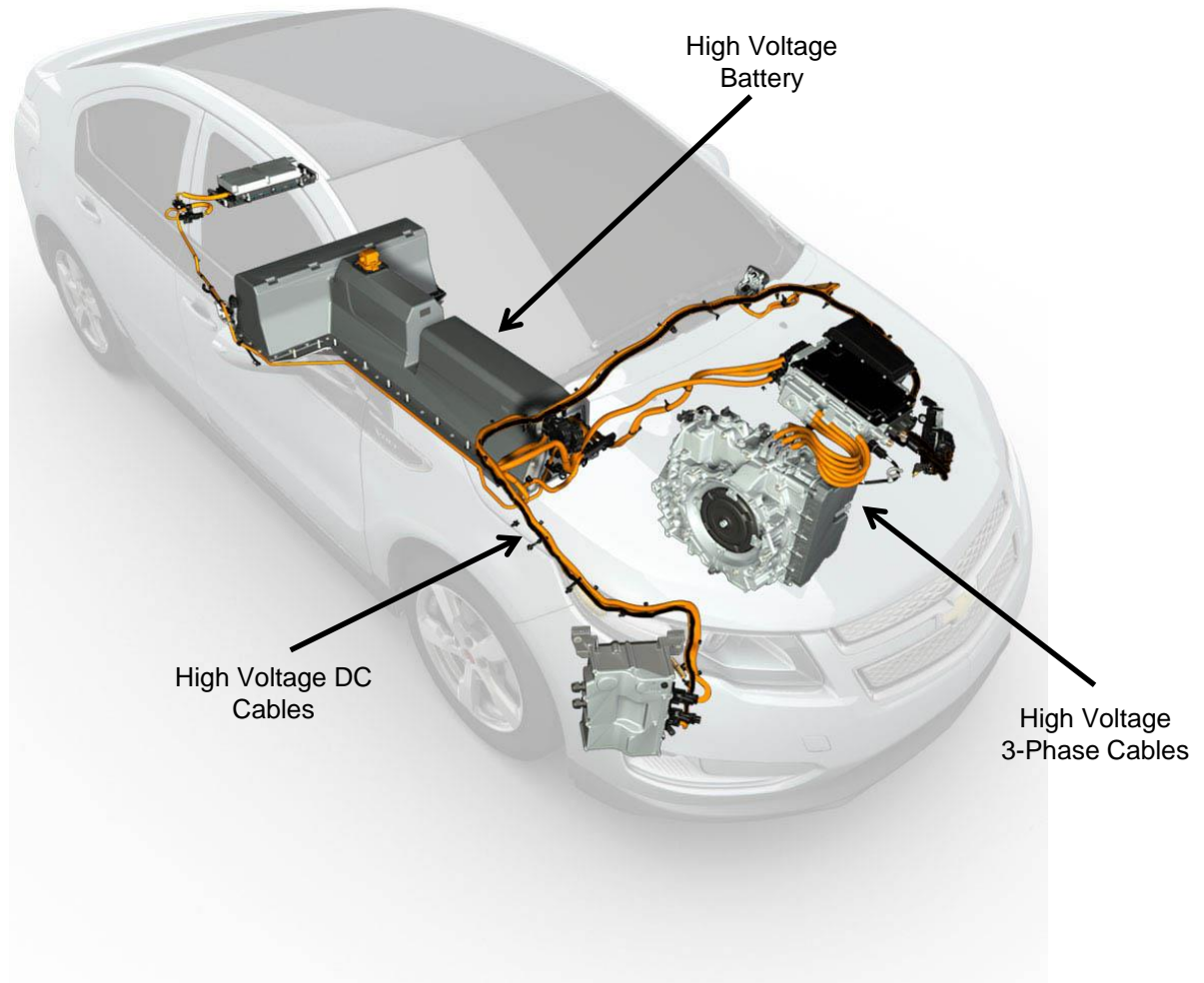

Chevrolet Volt Air Bags

The Volt is equipped with eight air bags to protect the occupant in front, rear, side and rollover crashes for 360° of protection.

The Volt is one of the few vehicles with knee air bags which helps reduce injuries to the front occupant's legs.

There are dual pretensioner seatbelts that work together with the air bag system to protect the occupant in the event of a crash.

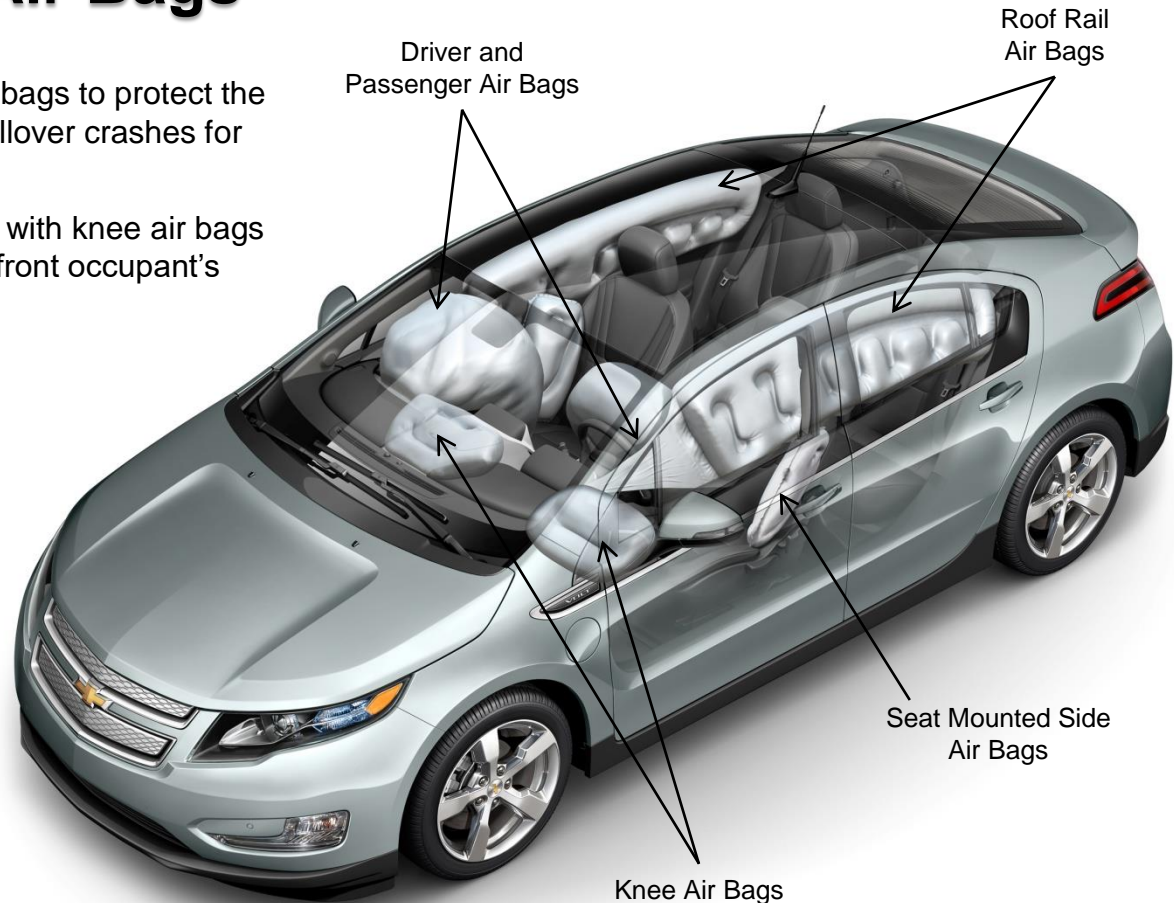

Air Bag Deployment

The contactors within the high voltage battery are commanded open whenever one or more airbags deploy. This interrupts the 360 volt electrical system and discontinues current flow through the high voltage cables.

This vehicle is equipped with dual-stage air bags and the appearance of deployed air bags does not ensure all stages of the air bags have deployed.

Therefore, disabling 12 volt power is essential to ensure personal safety even if the airbags in the vehicle appear to have been deployed. After disabling 12 volt power, wait 1 minute to allow any un-deployed air bag reserve energy to dissipate.



DC Voltage Classifications

Chevrolet Volt vehicles use 360 volts which may be higher than you have encountered - they **MUST** be approached with caution.



Voltage Classifications

The Chevrolet Volt has two voltage levels:

- **Low voltage** – from 0 to 30 volts DC or 0 to 15 volts AC
- **High voltage** – any voltage greater than 60 volts DC or 30 volts AC

Classification	Low Voltage	High Voltage
Voltage Ranges	DC ≤ 30v AC ≤ 15v	DC > 60v AC > 30v RMS

Color coding identifies the different levels. Orange identifies high voltage cables.

High Voltage Labels

The Chevrolet Volt features a series of high voltage labels that enable quick identification of potential electrical hazards. The labels are attached on each high voltage component.

The labels are color coded to indicate the potential high voltage state

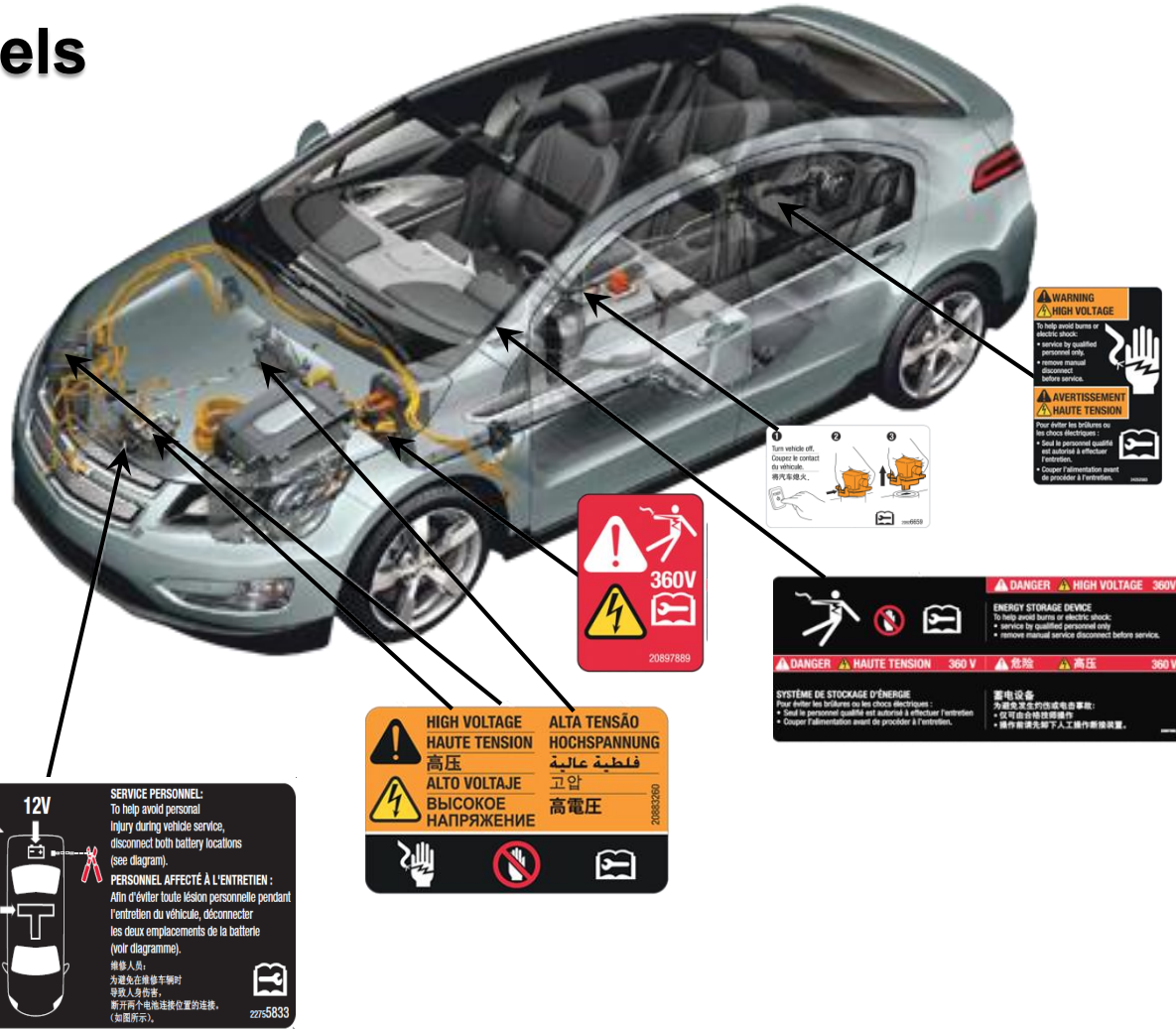

High Voltage Labels

The emergency / service personnel warning label is affixed at the front of the engine compartment and provides specific procedures for emergency personnel.



The high voltage warning labels are orange and indicate a potential shock hazard if high voltage is not properly disabled. The labels are located on all high voltage components with the exception of the high voltage battery which utilizes the danger label.

EMERGENCY PERSONNEL:
To help avoid personal injury in an emergency,
• Turn Ignition to "Off".
• Cut all positive cables connected at yellow tape (located behind fuse access panel in rear compartment area).

PERSONNEL AFFECTÉ AUX URGENCES :
Afin d'éviter toute lésion personnelle, effectuer ce qui suit en cas d'urgence :
• Mettre la clé de contact sur « Off » (arrêt).
• Couper tous les câbles positifs connectés au niveau du ruban jaune (situé à l'arrière du panneau d'accès des fusibles dans la zone du compartiment arrière).

应急人员：
为避免人身伤害，在出现紧急情况时，
• 将点火置于“关”的位置。
• 切断在黄色胶带处连接的所有正极线缆（位于后车厢区的保险丝检修）。

SERVICE PERSONNEL:
To help avoid personal injury during vehicle service, disconnect both battery locations (see diagram).

PERSONNEL AFFECTÉ À L'ENTRETIEN :
Afin d'éviter toute lésion personnelle pendant l'entretien du véhicule, déconnecter les deux emplacements de la batterie (voir diagramme).

维修人员：
为避免在维修车辆时导致人身伤害，
断开两个电池连接位置的连接。
(如图所示)。

22755833

The high voltage danger labels are red and indicate that high voltage is present at all times. These labels are located on the high voltage battery.



High Voltage Labels & First Responder Tags

The First Responder cable cut tag is wrapped around the low voltage positive battery cable and is located in the rear compartment behind the fuse panel door. To help ensure that low voltage is not holding the high voltage contactors closed, cut the cable before any extrication work is performed.

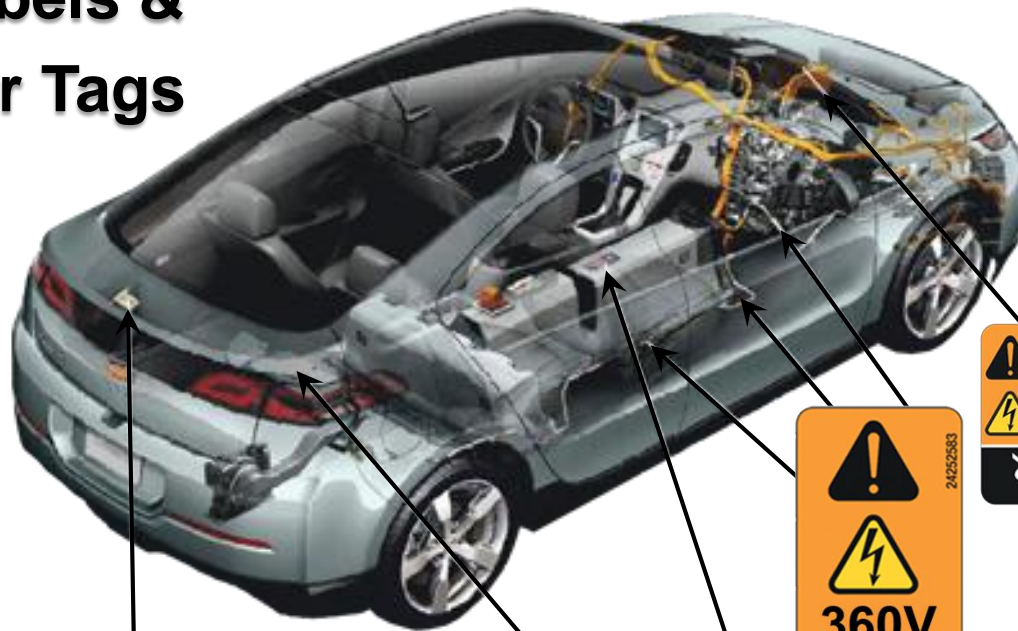

First Responder Labels

GM has implemented the labels shown here to help First Responders safely disable the vehicle in an emergency situation. The cable cut tag is yellow and wraps around the low voltage positive cable to indicate where emergency personnel must cut the cable.



Important:

Cut through the red positive low voltage cable on each side of the tag to remove a section of the cable to ensure the cables cannot inadvertently reconnect.

To Disable the 12V Power

1. Press the Start button on the center instrument panel to turn OFF the ignition.
2. Cut the 12V positive battery cable at the yellow tag cut position. The cable is identified by the yellow First Responder tag. The tag is located behind the left rear closeout panel in the rear compartment of the vehicle.



Note: After disabling 12V power, wait 1 minute to allow any un-deployed air bag reserve energy to dissipate.

Important:

Cut through the red positive low voltage cable on each side of the tag to remove a section of the cable to ensure they cannot inadvertently reconnect.



Disabling a Volt

The Manual Service Disconnect (MSD) may also be removed to further ensure the high voltage system is disabled within the battery. The MSD physically interrupts the high voltage cables internal to the battery. There is a label that illustrates the removal of the MSD which is located underneath the center console box.

Note: There is high voltage in the battery even if the MSD is removed.

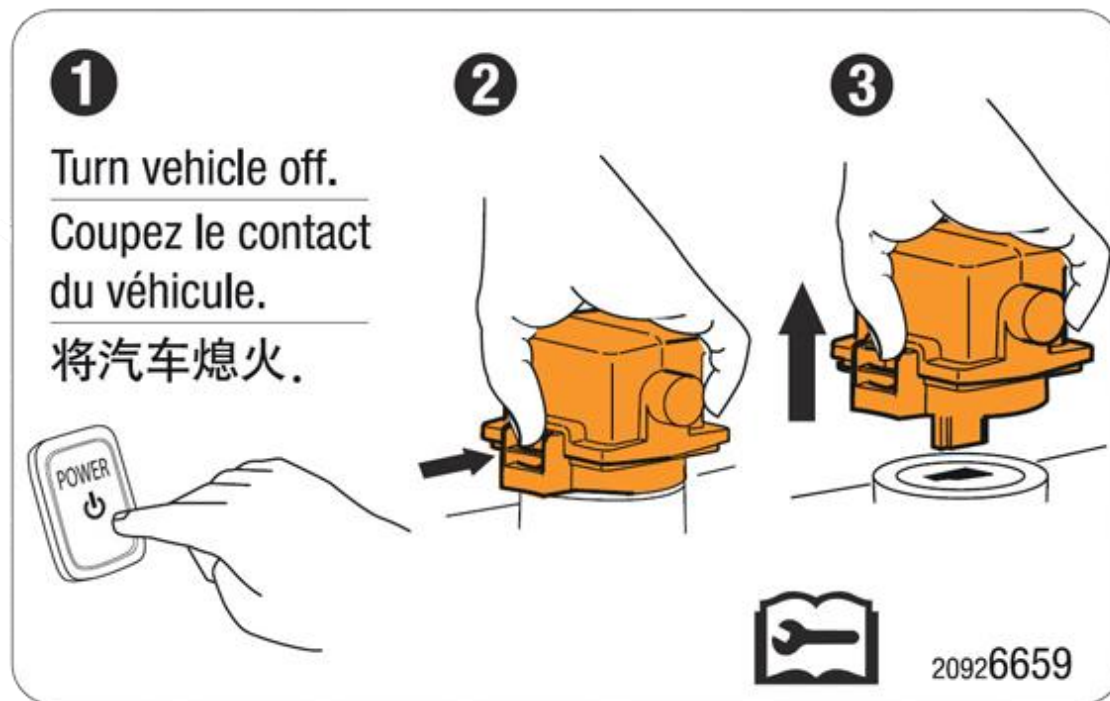

High Voltage Cables - DO NOT CUT ZONES

The high voltage cables in the Chevrolet Volt are highly protected and should not interfere with any extraction procedures. However, performing the disabling procedure prior to work eliminates electrical current flow through the 12 volt system and disables the high voltage electrical system, external to the 360V battery. No further action is required.

DANGER: Do NOT cut the orange high voltage 360 volt cables. Cutting these cables can result in serious injury or death. No matter what disable method you have performed, always assume the high voltage cables and components contain high voltage.

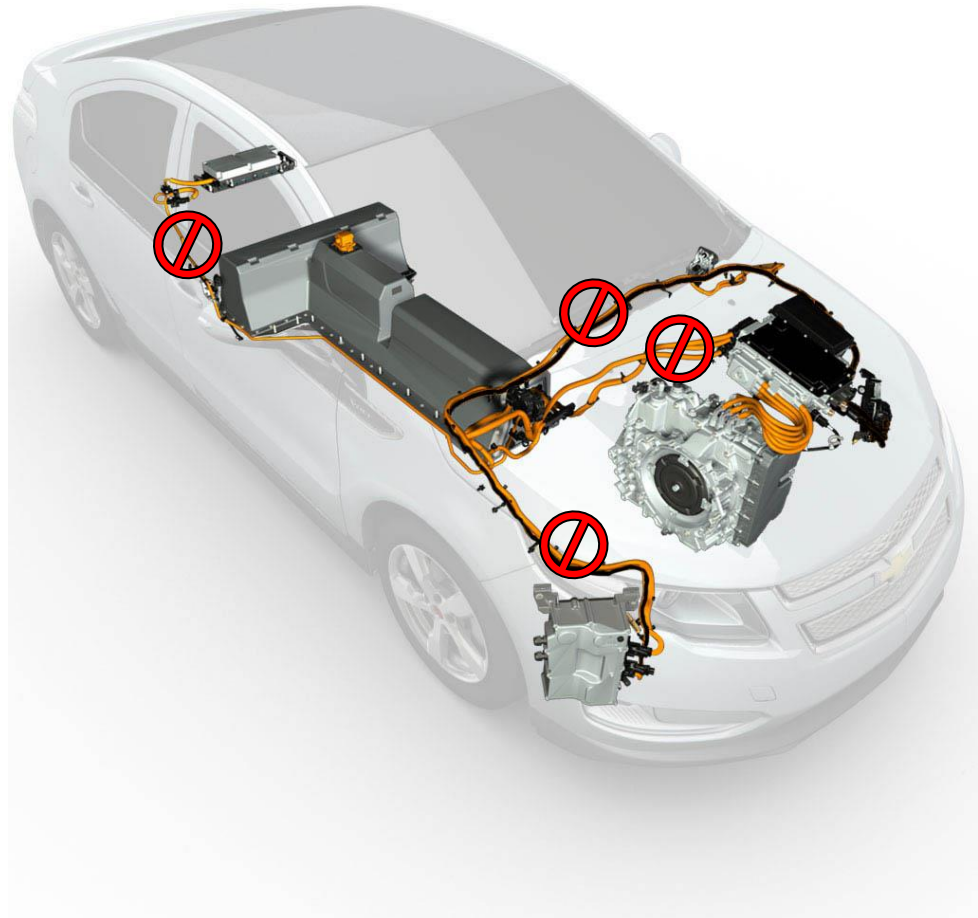

Vehicle DO NOT CUT ZONES

Do NOT cut the:

- Center tunnel area or the area under the rear seats. The 360 volt battery is installed in this area.
- Roof rails near the lift gate hinge. Side curtain air bag inflators and lift gate hold open struts are located in this area
- Front seat back on the outboard area, contains side air bags.
- B pillar near the rocker, contains the seat belt retractor pretensioner. Note: The outboard area of the front seat lower frame houses an additional seat belt pretensioner.

WARNING: Do NOT cut into the vehicle until the 12V electrical system has been disabled. Cutting into the vehicle prior to disconnecting and isolating the 12V electrical energy sources may cause air bag deployment resulting in serious injury.

DO NOT CUT HERE. Side curtain air bags and lift gate hold open struts.



DO NOT CUT HERE. The Volt battery has 360 volt electrical potential at all times. It is inside the center tunnel and under the rear seat area.

High Strength Steel

The Volt has been designed to protect the occupant(s) during a collision. The body structure is nearly 80% high strength steel. The occupant 's are protected from front, rear and side impacts by a structural cage created by the underlying vehicle structural design.

Additional crumple zones protect the occupant with front, side and rear rails that are designed to crush in a crash.



First Responder Considerations

Approaching a vehicle that is plugged in

Upon arriving at a location with a Volt plugged in for charging, you should first unplug the vehicle. If access to unplug the vehicle is unavailable, “remove charge power” from the vehicle. This can be done by turning off the power to the charge station.

Fire

The battery on fire will not explode. If battery cells reach high enough temperature, they vent and release electrolyte. Battery electrolyte is flammable. Use copious amounts of water to cool the battery and extinguish the fire. ABC dry chemical extinguisher will not extinguish a battery fire.

Water

The high voltage battery is sealed and isolated from the vehicle chassis. If the vehicle is immersed in water, you will not be electrocuted by touching the vehicle.

Locate and review the Lithium-Ion Battery Chemistry Material Safety Data Sheet for more information.



Conclusion

General Motors is committed to making your job as safe as possible.

We are confident the information contained in this guide will prove useful as you prepare to assist those involved in an emergency event.



For information regarding modification of GM's First Responder Information for other uses, contact GM's Licensing Manager at: GM Licensing Program Hdqtrs, 5775 Enterprise Ct. Warren, MI 48092, Attn: Licensing Coordinator